



GEOMETRIC GLASS

PIU GEOMETRIC GLASS

H | MAX. 300 CM

W | 80-140 CM



Isometry/
Izometria



Isometry/
Izometria

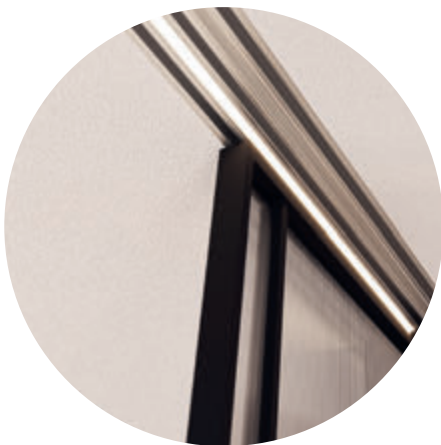

Guiding track with LED/
Prowadnica górna z LED



No bottom track/
Brak toru dolnego

Aluminum structures/
Struktury aluminium



white/
lacquered RAL/
biały/lakier RAL

anthracite/
antracyt

gold/
złoty

copper/
miedź

brushed brown/
brąz
szcztokowany

brushed black/
czarny
szcztokowany

Types of glass 6 mm/
Rodzaje szkła 6 mm

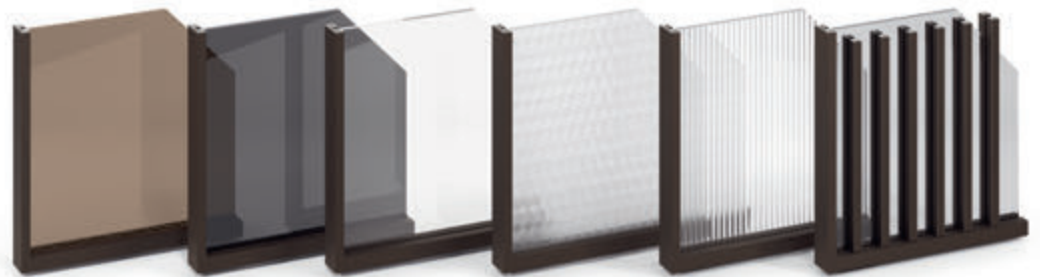

bronze/
brąz

black/
czarny

graphite/
grafit

optiwhite/
optiwhite

hexa/
heksa

decorative/
dekoracyjne

Door leaf finishes/
Możliwości wykończenia skrzydła

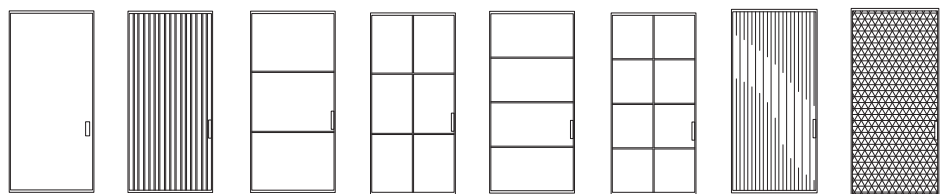

Geometric
Glass

Geometric
Glass
Stripe

Geometric
Glass
Loft 3P

Geometric
Glass
Loft 3PP

Geometric
Glass
Loft 4P

Geometric
Glass
Loft 4PP

Geometric
Glass
Deco

Geometric
Glass
Hexa

Geometric Glass Stripe sizes/
Rozmiary Geometric Glass Stripe

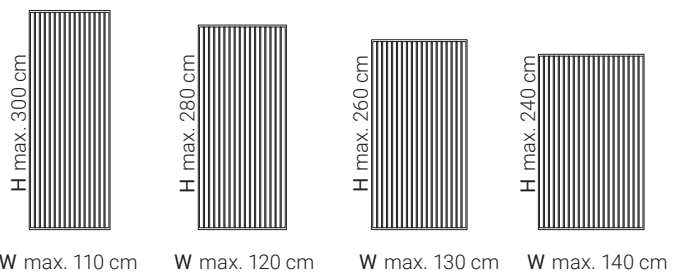

H max. 300 cm

H max. 280 cm

H max. 260 cm

H max. 240 cm

W max. 110 cm

W max. 120 cm

W max. 130 cm

W max. 140 cm

SLIDING SYSTEM 1S

SLIDING SYSTEM ON 1S RAIL/ SYSTEM PRZESUWNY NA SZYNIIE 1S

Mounting system for wall/
System mocowania do ściany

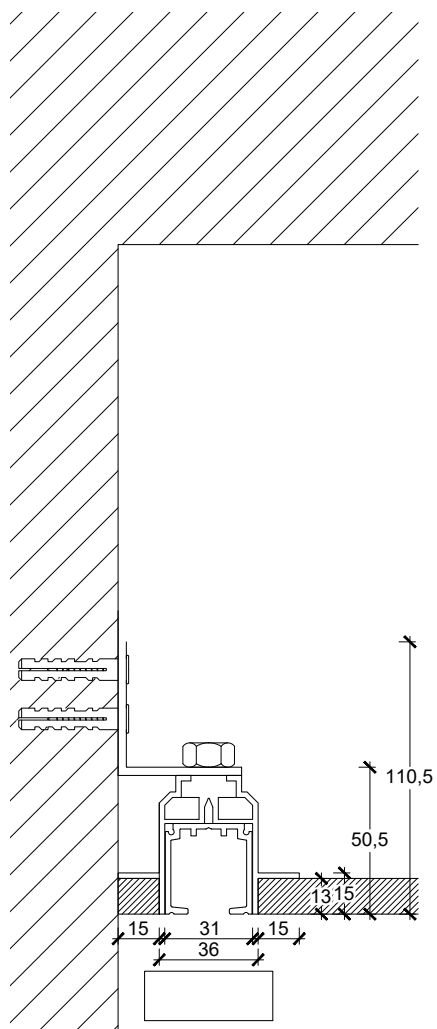

Mounting system for ceiling/
System mocowania do sufitu

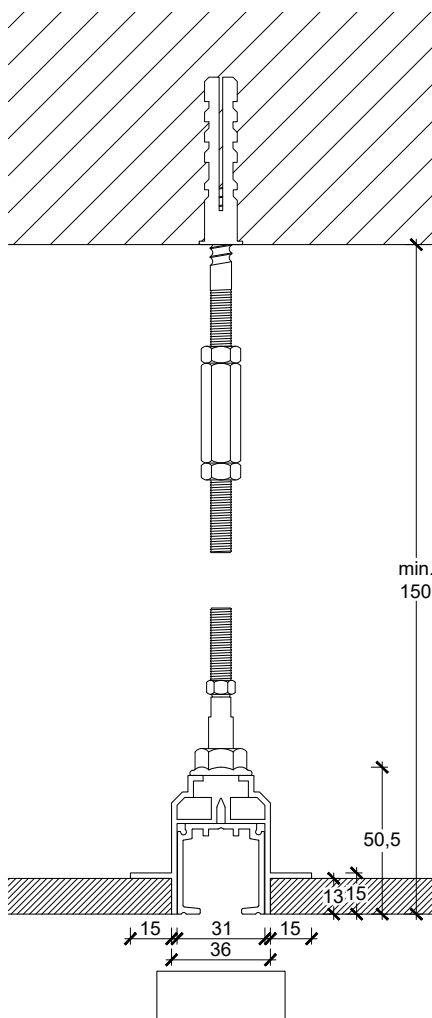

SLIDING SYSTEM ON **1S RAIL** – **1-2 DOORS LEAF/**
 SYSTEM PRZESUWNY NA SZYNIIE 1S – 1-2 SKRZYDŁA

Mounting in dropped ceiling/
 Montaż w suficie podwieszanym

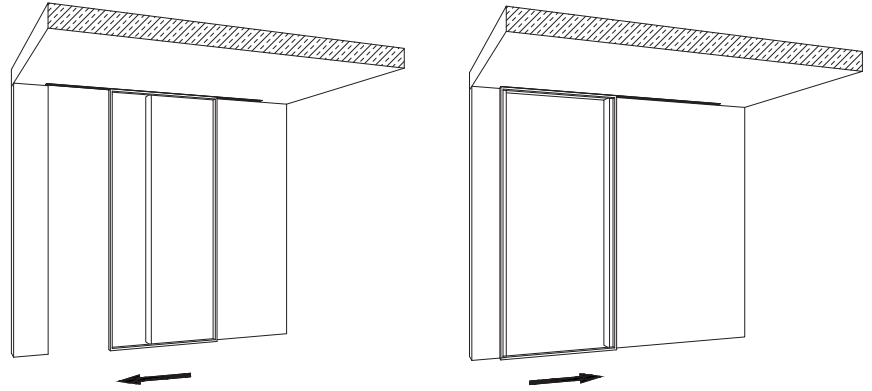

Mounting in dropped ceiling/
 Montaż w suficie podwieszanym

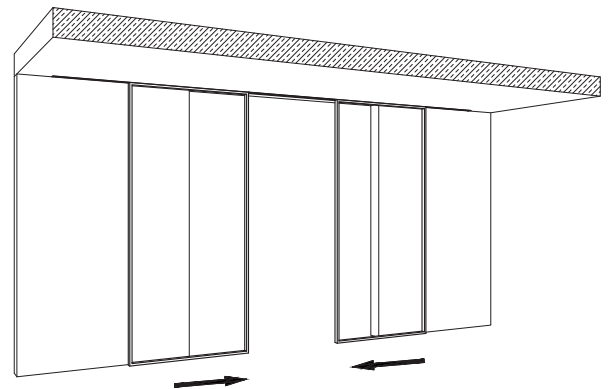

Door leaf opening/
 Kierunek otwierania

To the right/
 W prawo

closed/zamknięte



open/otwarte



To the left/
 W lewo

closed/zamknięte



open/otwarte

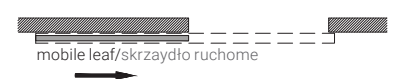

2 doors to the
 left/right/
 2 skrzydła
 w prawo/lewo

closed/zamknięte



open/otwarte

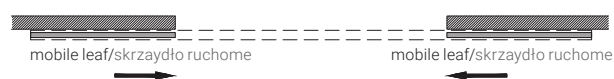

SLIDING SYSTEM 2S

SLIDING SYSTEM ON 2S RAIL/ SYSTEM PRZESUWNY NA SZYNIE 2S

Mounting system for wall/
System mocowania do ściany

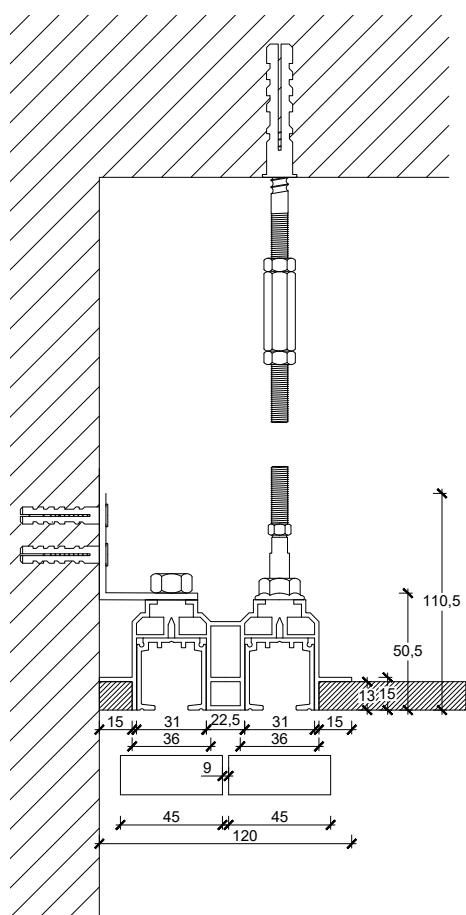

Mounting system for ceiling/
System mocowania do sufitu

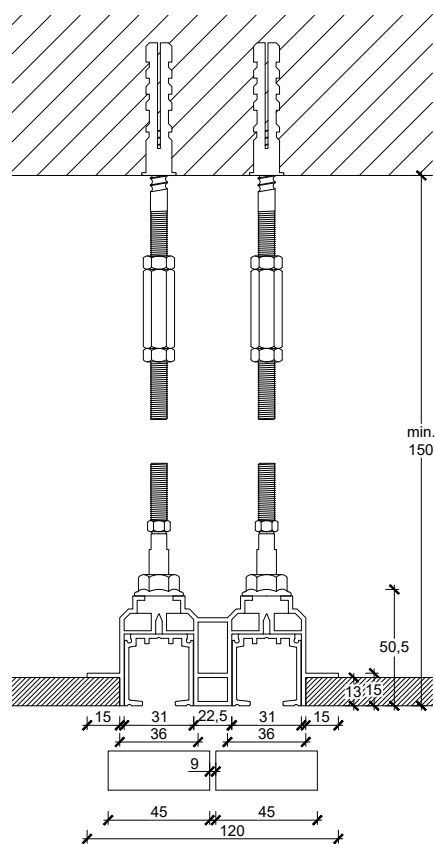

SLIDING SYSTEM ON **2S RAIL** – **2 DOOR LEAF**/
 SYSTEM PRZESUWNY NA SZYNIIE 2S – 2 SKRZYDŁA

Mounting in dropped ceiling/
 Montaż w suficie podwieszanym

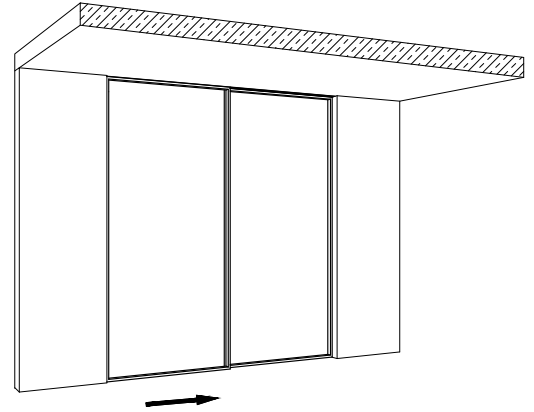

Mounting in dropped ceiling/
 Montaż w suficie podwieszanym

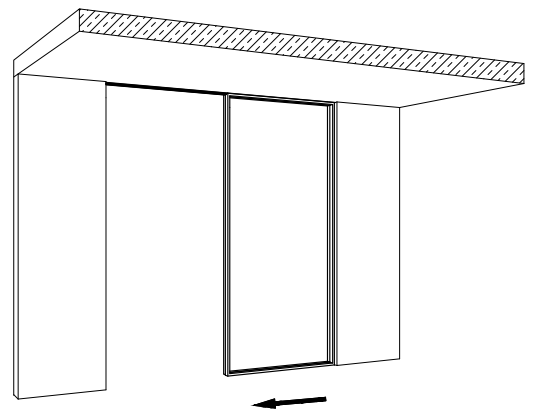

Door leaf opening/
 Kierunek otwierania

To the right/
 W prawo

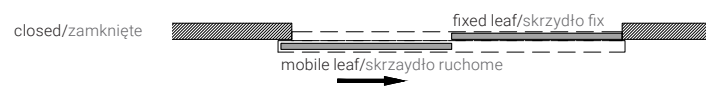

To the left/
 W lewo

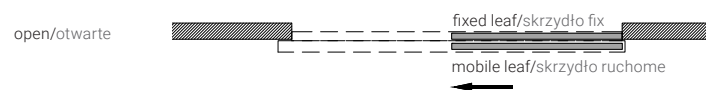

SLIDING SYSTEM ON **2S RAIL** – **3 DOOR LEAF**/
 SYSTEM PRZESUWNY NA SZYNIIE **2S** – **3 SKRZYDŁA**

Mounting in dropped ceiling/
 Montaż w suficie podwieszanym

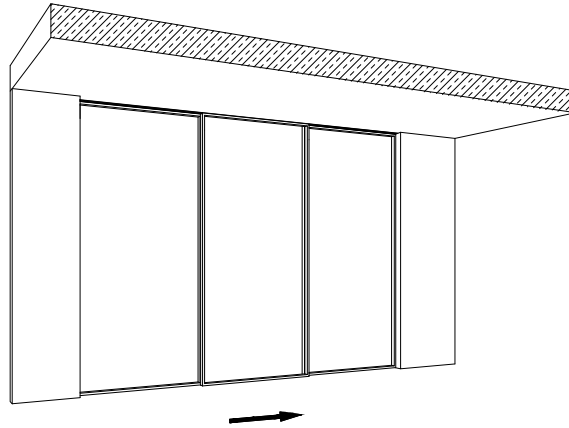

Mounting in dropped ceiling/
 Montaż w suficie podwieszanym

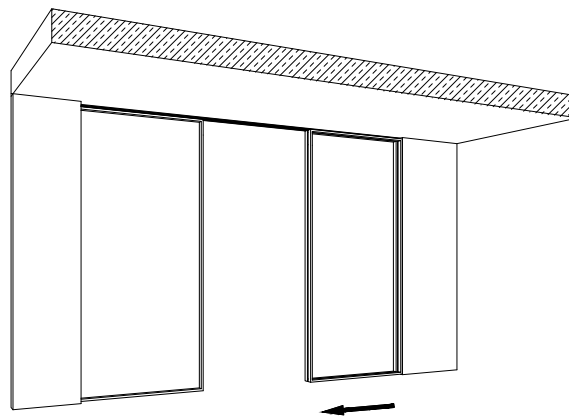

Door leaf opening/
 Kierunek otwierania

To the right/
 W prawo

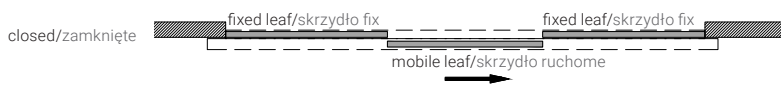

To the left/
 W lewo

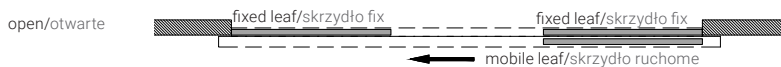

To the right/
 W prawo

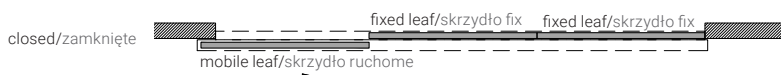

To the left/
 W lewo

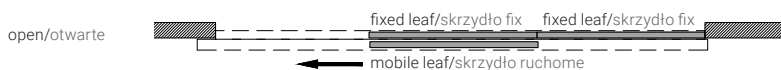

SLIDING SYSTEM ON **2S RAIL** – **4 DOOR LEAF**/
SYSTEM PRZESUWNY NA SZYNIIE 2S – 4 SKRZYDŁA

Mounting in dropped ceiling/
Montaż w suficie podwieszanym

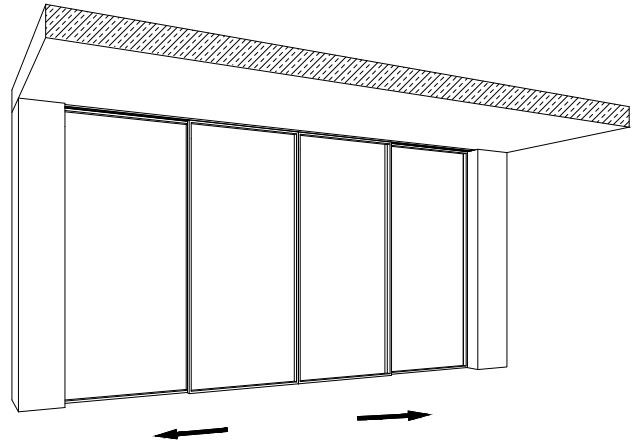

Mounting in dropped ceiling/
Montaż w suficie podwieszanym

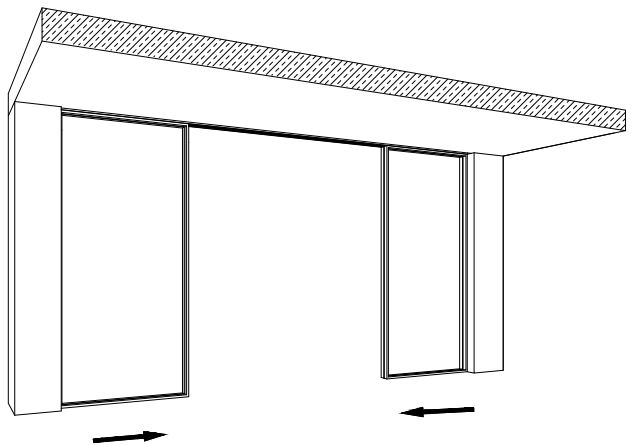

Door leaf opening/
Kierunek otwierania

2 doors to
the left/right
2 skrzydła prawo/
lewo

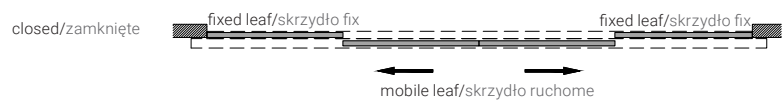

2 doors to
the left/right/
2 skrzydła
w prawo/lewo

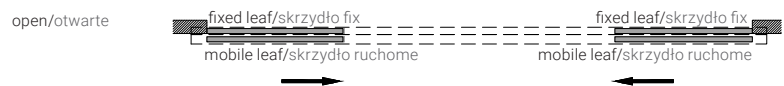

SLIDING SYSTEM 3S

SLIDING SYSTEM ON 2S RAIL/ SYSTEM PRZESUWNY NA SZYNIE 2S

Mounting system for wall/
System mocowania do ściany

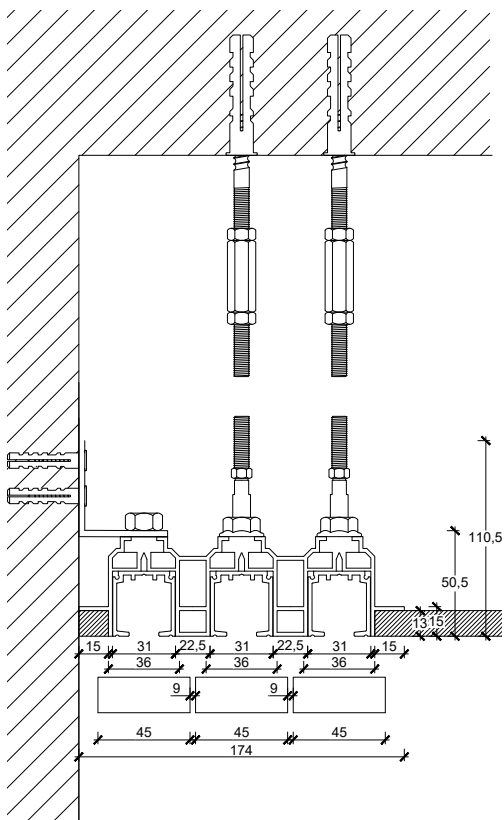

Mounting system for ceiling/
System mocowania do sufitu

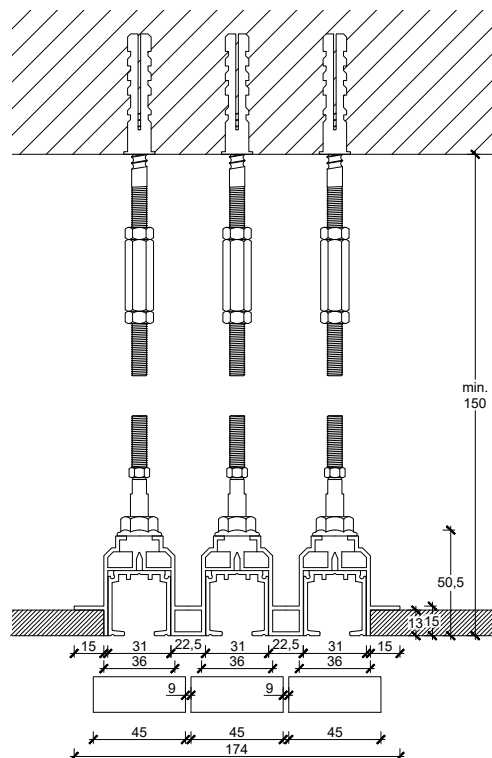

SLIDING SYSTEM ON **3S RAIL** – **3 DOOR LEAF**/
 SYSTEM PRZESUWNY NA SZYNI **4S** – **3 SKRZYDŁA**

Mounting in dropped ceiling/
 Montaż w suficie podwieszanym

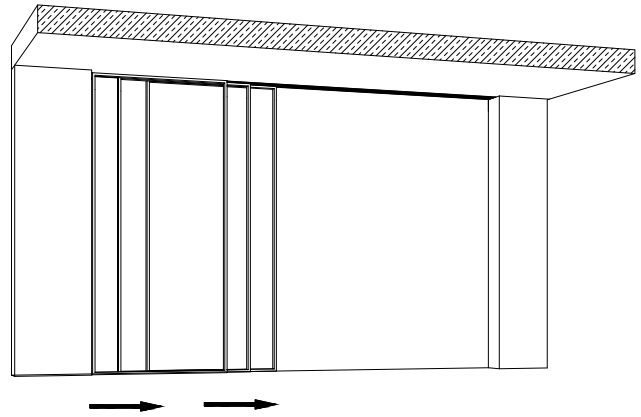

Mounting in dropped ceiling/
 Montaż w suficie podwieszanym

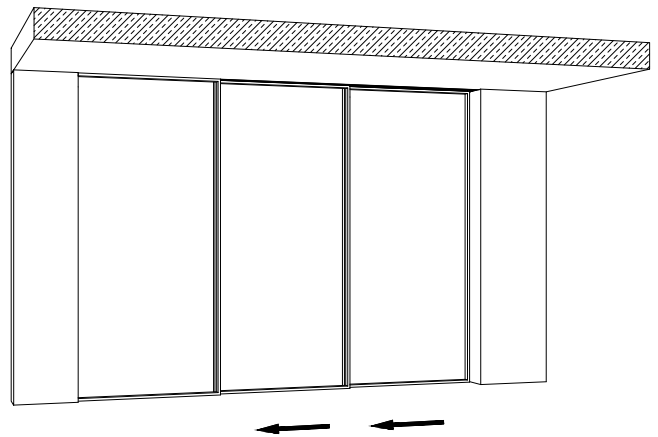

3S RAIL – **3 DOOR LEAF**/
SZYNA 3S / 3 SKRZYDŁA

2 doors to the right/
 2 skrzydła w prawo



2 doors to the left
 2 skrzydła w lewo

